

Serie Heavy

306SU

Nylon Cable Chain with opening frames

Inner height (D) 37 mm

Strong double share Sideband & Frame construction with large anti-friction triple-pin. Frames opening from inner and outer radius.

As standard the chain comes with frames every second link, on request with frames every link.

Vertical and horizontal modular separator system is available.

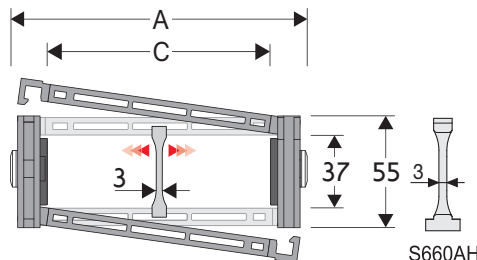

Separator

- Unassembled Part.no S306SM
- Assembled* Part.no S306SMMC

Strong-hold separator

for C > 250 mm

- Unassembled Part.no S660AH
- Assembled* Part.no S660AHMCI
- Assembled** Part.no S660AHMCE

Pin

- Part.no PG307

* for chain opening outer radius

** for chain opening inner radius

Technical characteristics when self-supported

| | |
|--------------|---------------------|
| Speed | 4 m/s |
| Acceleration | 10 m/s ² |

For higher requirements please consult our technical dept.

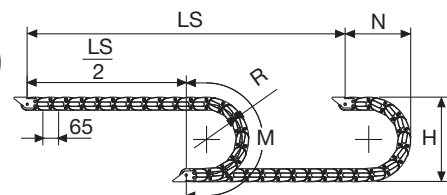

Length of chain (L)

Half travel distance ($\frac{LS}{2}$)

plus length of curve (M)

$$L = \frac{LS}{2} + M$$

| R | H | N | M |
|-----|-----|-----|------|
| mm | mm | mm | mm |
| 075 | 208 | 170 | 370 |
| 107 | 272 | 205 | 470 |
| 150 | 358 | 245 | 605 |
| 200 | 458 | 295 | 760 |
| 250 | 558 | 345 | 920 |
| 300 | 658 | 395 | 1075 |

| A | B | C | D | R | Weight/m | Chain |
|-----|----|-----|----|-------------------------|----------|----------------|
| mm | mm | mm | mm | mm | kg | Part Number |
| 79 | 55 | 43 | 37 | 075-107-150-200-250-300 | 1,61 | 306SU043 □□□ * |
| 90 | 55 | 54 | 37 | 075-107-150-200-250-300 | 1,61 | 306SU054 □□□ * |
| 104 | 55 | 68 | 37 | 075-107-150-200-250-300 | 1,68 | 306SU068 □□□ * |
| 110 | 55 | 74 | 37 | 075-107-150-200-250-300 | 1,70 | 306SU074 □□□ * |
| 114 | 55 | 78 | 37 | 075-107-150-200-250-300 | 1,72 | 306SU078 □□□ * |
| 124 | 55 | 88 | 37 | 075-107-150-200-250-300 | 1,74 | 306SU088 □□□ * |
| 129 | 55 | 93 | 37 | 075-107-150-200-250-300 | 1,74 | 306SU093 □□□ * |
| 136 | 55 | 100 | 37 | 075-107-150-200-250-300 | 1,76 | 306SU100 □□□ * |
| 146 | 55 | 110 | 37 | 075-107-150-200-250-300 | 1,77 | 306SU110 □□□ * |
| 154 | 55 | 118 | 37 | 075-107-150-200-250-300 | 1,82 | 306SU118 □□□ * |
| 165 | 55 | 129 | 37 | 075-107-150-200-250-300 | 1,85 | 306SU129 □□□ * |
| 179 | 55 | 143 | 37 | 075-107-150-200-250-300 | 1,89 | 306SU143 □□□ * |
| 204 | 55 | 168 | 37 | 075-107-150-200-250-300 | 1,96 | 306SU168 □□□ * |
| 229 | 55 | 193 | 37 | 075-107-150-200-250-300 | 2,04 | 306SU193 □□□ * |
| 240 | 55 | 204 | 37 | 075-107-150-200-250-300 | 2,07 | 306SU204 □□□ * |
| 254 | 55 | 218 | 37 | 075-107-150-200-250-300 | 2,11 | 306SU218 □□□ * |
| 281 | 55 | 245 | 37 | 075-107-150-200-250-300 | 2,19 | 306SU245 □□□ * |
| 290 | 55 | 254 | 37 | 075-107-150-200-250-300 | 2,22 | 306SU254 □□□ * |
| 315 | 55 | 279 | 37 | 075-107-150-200-250-300 | 2,29 | 306SU279 □□□ * |
| 341 | 55 | 305 | 37 | 075-107-150-200-250-300 | 2,34 | 306SU305 □□□ * |
| 363 | 55 | 327 | 37 | 075-107-150-200-250-300 | 2,41 | 306SU327 □□□ * |
| 391 | 55 | 355 | 37 | 075-107-150-200-250-300 | 2,49 | 306SU355 □□□ * |

*Complete the code by inserting the value of the radius (R): Ex. 306SU110 □□□ □

Chain equipped with nylon frame every pitch: complete the code by inserting the letter D.
Ex. 306SU110150 □□



Self-Supporting Capacity Diagram

The maximum length of the self-supporting capacity ($\frac{LS}{2}$) in relationship to the weight of the cables and hoses contained per linear metre.

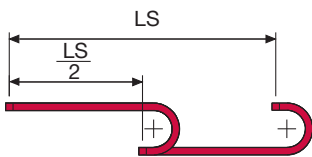
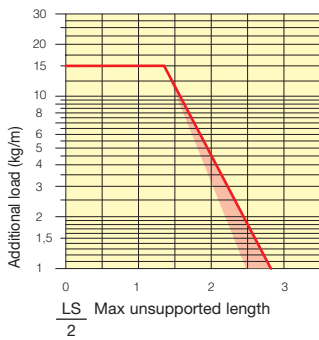

The red marking in the diagram area considers the difference of weight between various widths of chains assembled with nylon frames every second pitch.

For applications with $\frac{LS}{2}$ and weights not included in the area of the diagram showing self-supporting capacity, verify the possible use of support rollers (see page 30).

End Brackets

The end brackets set allows the two ends of the chain to be attached to the equipment. Set complete with tie-wrap clamps available on request.

Nylon Type

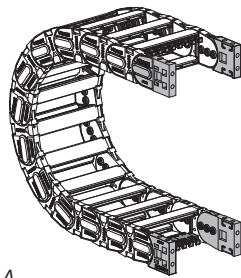

Fig. A
The chain can be fixed frontally, inner or outer radius. (Fig A)

Nylon Type

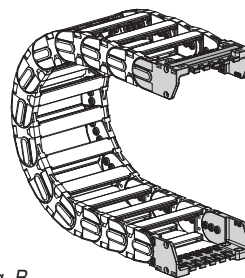
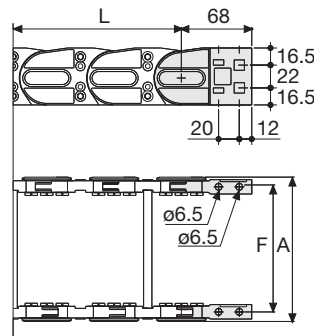

Fig. B
Chain fixed outside the radius. (Fig B)
See end brackets mounting variations page 31.



| Chain Type | F mm |
|------------|------|
| 306SU043 | 61 |
| 306SU054 | 72 |
| 306SU068 | 86 |
| 306SU074 | 92 |
| 306SU078 | 96 |
| 306SU088 | 106 |
| 306SU093 | 111 |
| 306SU100 | 118 |
| 306SU110 | 128 |
| 306SU118 | 136 |
| 306SU129 | 147 |
| 306SU143 | 161 |
| 306SU168 | 186 |
| 306SU193 | 211 |
| 306SU204 | 222 |
| 306SU218 | 236 |
| 306SU245 | 263 |
| 306SU254 | 272 |
| 306SU279 | 297 |
| 306SU305 | 323 |
| 306SU327 | 345 |
| 306SU355 | 373 |

Nylon Type Part Numbers

| Complete Set Assembled | |
|--------------------------|------------------|
| Chain Type | End Brackets Set |
| 306SU... | AN306KM |
| Complete Set Unassembled | |
| Chain Type | End Brackets Set |
| 306SU... | AN306K |
| Tiewrap Clamp | |
| Assembl. | CFC306S □□□*KM |
| Unassembl. | CFC306S □□□*K |

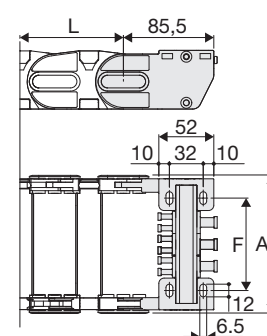

| Chain Type | F mm |
|------------|------|
| 306SU043 | 36 |
| 306SU054 | 47 |
| 306SU068 | 61 |
| 306SU074 | 67 |
| 306SU078 | 71 |
| 306SU088 | 81 |
| 306SU093 | 86 |
| 306SU100 | 93 |
| 306SU110 | 103 |
| 306SU118 | 111 |
| 306SU129 | 122 |
| 306SU143 | 136 |
| 306SU168 | 161 |
| 306SU193 | 186 |
| 306SU204 | 197 |
| 306SU218 | 211 |
| 306SU245 | 238 |
| 306SU254 | 247 |
| 306SU279 | 272 |
| 306SU305 | 298 |
| 306SU327 | 320 |
| 306SU355 | 348 |

Nylon Type Part Numbers

| Complete Set Assembled | |
|--------------------------|------------------|
| Chain Type | End Brackets Set |
| 306SU... | ANL306KM □** |
| Complete Set Unassembled | |
| Chain Type | End Brackets Set |
| 306SU... | ANL306K □** |
| Tiewrap Clamp | |
| Assembl. | SFCTL306 □□□*KM |
| Unassembl. | SFCTL306S □□□*K |

SFCTL not applicable for C=43

Serie Heavy

306SU

Nylon Cable Chain with opening frames

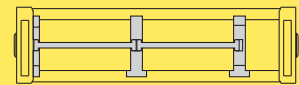

Separation System To choose the separators see page 216

Bright Zinc Plated Steel Type***

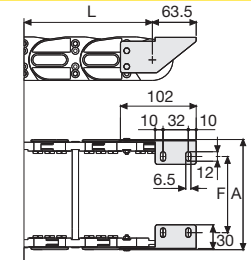
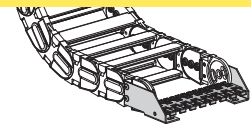

F = A-43

Bright Zinc Plated Steel Type Part Numbers

| Complete Set Assembled | |
|--------------------------|------------------|
| Chain Type | End Brackets Set |
| 306SU... | A306SKM □** |
| Complete Set Unassembled | |
| Chain Type | End Brackets Set |
| 306SU... | A306SK □** |
| Tiewrap Clamp | |
| Assembl. | SFCT306S □□□*KM |
| Unassembl. | SFCT306S □□□*K |

* Inner width (C)
** 1=Pos.1; 2=Pos.2; 3=Pos.3
*** Available on request in stainless steel